

TKRL 661 NB

12NC: 859991636350

GTIN (EAN) code: 8003437625640

Whirlpool

SENSING THE DIFFERENCE

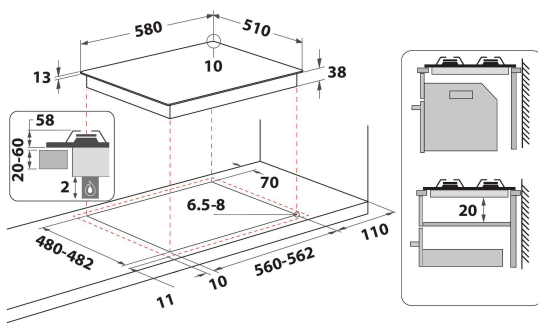

MAIN FEATURES

Product group	Ploča za kuhanje
Construction type	Ugradbeni
Type of control	Mechanical
Type of control settings	Knob
Number of gas burners	4
Number of electric cooking zones	0
Number of electric plates	0
Number of radiant plates	0
Number of halogen plates	0
Number of induction plates	0
Number of electric warming zones	0
Location of control panel	Front
Basic surface material	Enamelled
Main colour of product	Antracit
Electrical connection rating (W)	0
Gas connection rating (W)	7800
Gas type	Methane
Current (A)	0,6
Voltage (V)	220-240
Frequency (Hz)	50/60
Length of Electrical Supply Cord (cm)	100
Plug type	Ne
Gas connection	-
Width of the product	580
Height of the product	38
Depth of the product	510
Minimum niche height	0
Minimum niche width	555
Niche depth	480
Net weight (kg)	11
Automatic programmes	Ne

TECHNICAL FEATURES

Power on indicator	Ne
Number of indicators	0
Type of regulation	MINI WOK
Type of lid	Glass
Residual heat indicator	Without
Main on/off switch	Ne
Safety device	Yes
Timer	Ne

ENERGY LABEL

Energy input	Gaz
--------------	-----